

BHA853022 Series

Features :

- Use on particularly high current circuits due to its extremely low DC resistance.
- Can match power lines to a maximum of 6A DC.
- Operating temperature range of -55°C to +125°C
- Storage temperature range of -40°C to +85°C

Applications :

- Various power lines of electronic equipment.
- Various automotive electronics.
- Mother board, tablet PC, laptop, desktop computer and peripheral equipment.
- Digital communication equipment.

Shapes And Dimensions : (Unit :mm)

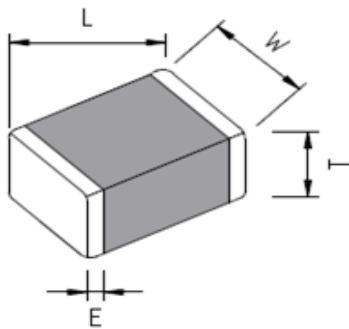

L	W	T	E
8.5 ± 0.2	3.05 ± 0.2	2.28 ± 0.2	0.69~1.09

Part Number Code :

BHA 853022 A 121 -E

① ② ③ ④ ⑤

- 1 : Series
- 2 : Dimensions L x W x T
- 3 : Material Code
- 4 : Normal Impedance
- 5 : Lead-Free

Reflow Profile :

Peak Temp : 260°C
Max time above 230°C 50sec
Max time above 200°C 70sec

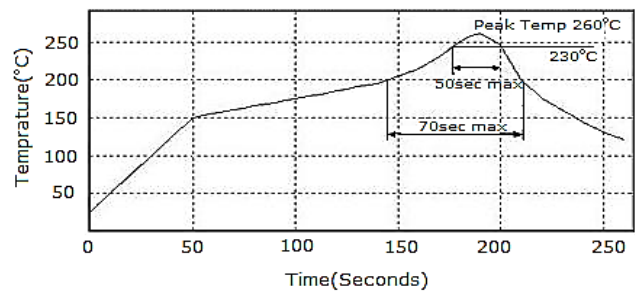

BHA853022 Series

Part No.	Impedance Ω±25% @100MHz	DCR(Ω) (max.)	Rated Current (mA) (max.)
BHA853022I101 10A	100	0.004	10000

